

SONY®

VAIO® Notebook User Guide

PCG-F520



Notice to Users

© 2000 Sony Electronics Inc. All rights reserved. This manual and the software described herein, in whole or in part, may not be reproduced, translated, or reduced to any machine-readable form without prior written approval.

SONY ELECTRONICS INC. PROVIDES NO WARRANTY WITH REGARD TO THIS MANUAL, THE SOFTWARE, OR OTHER INFORMATION CONTAINED HEREIN AND HEREBY EXPRESSLY DISCLAIMS ANY IMPLIED WARRANTIES OF MERCHANTABILITY OR FITNESS FOR ANY PARTICULAR PURPOSE WITH REGARD TO THIS MANUAL, THE SOFTWARE, OR SUCH OTHER INFORMATION. IN NO EVENT SHALL SONY ELECTRONICS INC. BE LIABLE FOR ANY INCIDENTAL, CONSEQUENTIAL, OR SPECIAL DAMAGES, WHETHER BASED ON TORT, CONTRACT, OR OTHERWISE, ARISING OUT OF OR IN CONNECTION WITH THIS MANUAL, THE SOFTWARE, OR OTHER INFORMATION CONTAINED HEREIN OR THE USE THEREOF.

Sony Electronics Inc. reserves the right to make any modification to this manual or the information contained herein at any time without notice. The software described herein is governed by the terms of a separate user license agreement.

This product contains software owned by Sony and licensed by third parties. Use of such software is subject to the terms and conditions of license agreements enclosed with this product. Some of the software may not be transported or used outside the United States. Software specifications are subject to change without notice and may not necessarily be identical to current retail versions.

Updates and additions to software may require an additional charge. Subscriptions to online service providers may require a fee and credit card information. Financial

services may require prior arrangements with participating financial institutions.

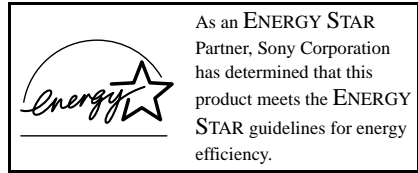

The International ENERGY STAR Office Equipment Program is an international program that promotes energy saving through the use of computers and other office equipment. The program backs the development and dissemination of products with functions that effectively reduce energy consumption. It is an open system in which business proprietors can participate voluntarily. The targeted products are office equipment such as computers, displays, printers, facsimiles and copiers. Their standards and logos are uniform among participating nations. ENERGY STAR is a U.S. registered mark.

Sony, i.LINK, VAIO and the VAIO logo are trademarks of Sony Corporation. Windows, Windows NT, and the Windows logo are registered trademarks of Microsoft Corporation. Intel, SpeedStep, and Pentium are trademarks of Intel Corporation.

This product incorporates copyright protection technology that is protected by method claims of certain U.S. patents and other intellectual property rights owned by Macrovision Corporation and other rights owners. Use of this copyright protection technology must be authorized by Macrovision Corporation, and is intended for home and other limited viewing uses only unless otherwise authorized by Macrovision Corporation. Reverse engineering or disassembly is prohibited.

All other trademarks are trademarks of their respective owners.

Owner's Record

The model number and serial number are located on the bottom of your Sony VAIO® Notebook. Record the serial number in the space provided here. Refer to the model and serial number when you call your Sony Service Center.

Model Number: PCG-9251

Serial Number: _____

Safety Information

WARNING

- To prevent fire or shock hazard, do not expose your notebook computer to rain or moisture.
- To avoid electrical shock, do not open the cabinet. Refer servicing to qualified personnel only.
- Never install modem or telephone wiring during a lightning storm.
- Never install telephone jacks in wet locations unless the jack is specifically designed for wet locations.
- Never touch uninsulated telephone wire or terminals unless the telephone line has been disconnected at the network interface.
- Use caution when installing or modifying telephone lines.
- Avoid using the modem during an electrical storm.
- Do not use the modem or a telephone to report a gas leak in the vicinity of the leak.
- A socket outlet should be as close as possible to the unit and easily accessible.

! **To change the backup battery, please contact your nearest Sony Service Center.**

! **Pour changer la pile de rechange, veuillez contacter votre centre de service Sony le plus près.**

! **For CD-ROM: The use of optical instruments with the CD-ROM drive will increase eye hazard.**

! **Pour le CD-ROM: L'utilisation d'instruments optiques avec les lecteurs CD-ROM augmente les risques pour les yeux.**

AVERTISSEMENT

- Pour prévenir tout risque d'incendie ou d'électrocution, garder cet appareil à l'abri de la pluie et de l'humidité.
- Pour prévenir tout risque d'électrocution, ne pas ouvrir le châssis de cet appareil et ne confier son entretien qu'à une personne qualifiée.
- Ne jamais effectuer l'installation de fil modem ou téléphone durant un orage électrique.
- Ne jamais effectuer l'installation d'une prise téléphonique dans un endroit mouillé à moins que la prise soit conçue à cet effet.
- Ne jamais toucher un fil téléphonique à découvert ou un terminal à moins que la ligne téléphonique n'ait été débranché de l'interface réseau.
- Soyez très prudent lorsque vous installez ou modifiez les lignes téléphoniques.
- Évitez d'utiliser le modem durant un orage électrique.
- N'utilisez pas le modem ni le téléphone pour prévenir d'une fuite de gaz si vous êtes près de la fuite.

- ❑ L'appareil doit être le plus près possible d'une prise murale pour en faciliter l'accès.

For questions regarding your product or for the Sony Service Center nearest you, call 1-888-476-6972 in the United States or 1-800-961-7669 in Canada. Sony Customer Support can be reached at www.sony.com/pcsupport

The number below is for FCC related matters only.

Regulatory Information

Declaration of Conformity

Trade Name: SONY
Model No.: PCG-9251
Responsible Party: Sony Electronics Inc.
Address: 1 Sony Drive
Park Ridge, NJ 07656
Telephone: 201-930-6972

This device complies with Part 15 of the FCC rules. Operation is subject to the following two conditions:

- (1) This device may not cause harmful interference, and
- (2) this device must accept any interference received, including interference that may cause undesired operation.

This equipment has been tested and found to comply with the limits for a Class B digital device, pursuant to Part 15 of the Rules. These limits are designed to provide reasonable protection against harmful interference in a residential installation. This equipment generates, uses, and can radiate radio frequency energy and, if not installed and used in accordance with the instructions, may cause harmful interference to radio communications. However, there is no guarantee that interference will not occur in a particular installation. If this equipment does cause harmful interference to radio or television reception, which can be determined by turning the equipment off and on, the user is encouraged to try to correct the

interference by one or more of the following measures:

- ❑ Reorient or relocate the receiving antenna.
- ❑ Increase the separation between the equipment and the receiver.
- ❑ Connect the equipment into an outlet on a circuit different from that to which the receiver is connected.
- ❑ Consult the dealer or an experienced radio/TV technician for help.

You are cautioned that any changes or modifications not expressly approved in this manual could void your authority to operate this equipment.

Only peripherals (computer input/output devices, terminals, printers, etc.) that comply with FCC Class B limits may be attached to this computer product. Operation with non-compliant peripherals is likely to result in interference to radio and television reception.

All cables used to connect peripherals must be shielded and grounded. Operation with cables, connected to peripherals, that are not shielded and grounded, may result in interference to radio and television reception.

FCC Part 68

This equipment complies with Part 68 of the FCC rules. On the bottom of this equipment is a label that contains, among other information, the FCC equivalence number (REN) for this equipment. If requested, this information must be provided to the telephone company.

This modem uses the USOC RJ-11 telephone jack.

The REN is used to determine the quantity of devices which may be connected to the telephone line. Excessive RENs on the telephone line may result in the devices not ringing in response to an incoming call. In most, but not all areas, the sum of the RENs should not exceed five (5.0). To be certain of the number of devices that may be connected to the line, as determined by the total RENs, contact the telephone company to determine the maximum REN for the calling area.

If the terminal equipment causes harm to the telephone network, the telephone company will notify you in advance that temporary discontinuance of service may be required. But if advance notice is not practical, the telephone company will notify the customer as soon as possible. Also, you will be advised of your right to file a complaint with the FCC if you believe it is necessary.

The telephone company may make changes in its facilities, equipment, operations or procedures that could affect the operations of the equipment. If this happens, the telephone company will provide advance notice in order for you to make the necessary modifications in order to maintain uninterrupted service.

If trouble is experienced with this equipment, please contact 1-888-4SONYPC (1-888-476-6972), or write to the Sony Customer Information Center, One Sony Drive, Park Ridge, NJ 07656, for repair and/or warranty information. If the trouble

is causing harm to the telephone network, the telephone company may request that you remove the equipment from the network until the problem is resolved.

Repair of this equipment should be made only by a Sony Service Center or Sony authorized agent. For the Sony Service Center nearest you, call 1-888-4SONYPC (1-888-476-6972).

This equipment cannot be used on public coin service provided by the telephone company. Connection to Party Line Service is subject to state and possible provincial tariffs. (Contact the state or provincial utility service commission, public service commission, or corporation commission, for information.)

Telephone Consumer Protection Act of 1991 (United States)

The Telephone Consumer Protection Act of 1991 makes it unlawful for any person to use a computer or other electronic device to send any message via a telephone facsimile machine unless such message clearly contains, in a margin at the top or bottom of each transmitted page or on the first page of the transmission, the date and time it is sent and an identification of the business, other entity, or individual sending the message, and the telephone number of the sending machine or such business, other entity, or individual.

In order to program this information into your facsimile machine, see your fax software documentation.

Telephone Consumer Guidelines (Canada)

Please refer to your telephone directory under 'Privacy Issues' and/or 'Terms of Service.' For more detailed information, please contact:

CRTC

Terrasses de la Chaudière, Tour centrale
1 promenade du Portage, 5 étage Hull PQ
K1A 0N2.

This Class B digital apparatus complies with Canadian ICES-003.

Cet appareil numérique de la classe B est conforme à la norme NMB-003 du Canada.

DISPOSAL OF LITHIUM ION BATTERY

You can return your unwanted lithium ion batteries to your nearest Sony Service Center or Factory Service Center.



In some areas the disposal of lithium ion batteries in household or business trash may be prohibited.

For the Sony Service Center nearest you, call 1-888-476-6972 in the United States or 1-800-961-7669 in Canada.

- ! **Do not handle damaged or leaking lithium ion batteries.**
- ! **Ne pas manipuler les batteries au lithium-ion qui fuient ou sont endommagées.**

! **Danger of explosion if battery is incorrectly replaced. Replace only with the same or equivalent type recommended by the manufacturer. Discard used batteries according to the manufacturer's instructions.**

! **Une batterie non conforme présente un danger d'explosion. La remplacer seulement par une batterie identique ou de type équivalent recommandé par le fabricant. Évacuer les batteries usées selon les directives du fabricant.**

! **The battery pack used in this device may present a fire or chemical burn hazard if mistreated. Do not disassemble, heat above 212°F (100°C) or incinerate. Dispose of used battery promptly. Keep away from children.**

! **La manutention incorrecte du module de batterie de cet appareil présente un risque d'incendie ou de brûlures chimiques. Ne pas démonter, incinérer ou exposer à une température de plus de 100°C. Évacuer promptement la batterie usée. Garder hors de portée des enfants.**

INDUSTRY CANADA NOTICE

NOTICE: The Industry Canada label identifies certified equipment. This certification means that the equipment meets certain telecommunications network protective, operational and safety requirements as prescribed in the appropriate Terminal Equipment Technical Requirements document(s). The Department does not guarantee the equipment will operate to the user's satisfaction.

Before installing this equipment, users should ensure that it is permissible to be connected to the facilities of the local telecommunications company. The equipment must also be installed using an acceptable method of connection.

The customer should be aware that compliance with the above conditions may not prevent degradation of service in some situations.

Repairs to certified equipment should be coordinated by a representative designated by the supplier. Equipment malfunctions or any repairs or alterations made by the user to this equipment may give the telecommunications company cause to request that the user disconnect the equipment.

Users should ensure for their own protection that the electrical ground connections of the power utility, telephone lines and internal metallic water pipe system, if present, are connected together. This precaution may be particularly important in rural areas.

Caution: Users should not attempt to make such connections themselves, but should contact the appropriate electric inspection authority, or electrician, as appropriate.

NOTICE: The Ringer Equivalence Number (REN) assigned to each terminal device provides an indication of the maximum number of terminals allowed to be connected to a telephone interface. The

termination on an interface may consist of any combination of devices subject only to the requirement that the sum of the Ringer Equivalence Numbers of all the devices does not exceed 5. The Ringer Equivalence Number for this equipment is 0.4.

AVIS DE L'INDUSTRIE CANADA

AVIS: L'étiquette d'Industrie Canada identifie le matériel homologué.

Cette étiquette certifie que le matériel est conforme aux normes de protection, d'exploitation et de sécurité des réseaux de télécommunications, comme le prescrivent les documents concernant les exigences techniques relatives au matériel terminal. Le Ministère n'assure toutefois pas que le matériel fonctionnera à la satisfaction de l'utilisateur.

Avant d'installer ce matériel, l'utilisateur doit s'assurer qu'il est permis de le raccorder aux installations de l'entreprise locale de télécommunication. Le matériel doit également être installé en suivant une méthode acceptée de raccordement. L'abonné ne doit pas oublier qu'il est possible que la conformité aux conditions énoncées ci-dessus n'empêche pas la dégradation du service dans certaines situations.

Les réparations de matériel homologué doivent être coordonnées par un représentant désigné par le fournisseur. L'entreprise de télécommunications peut demander à l'utilisateur de débrancher un appareil à la suite de réparations ou de modifications effectuées par l'utilisateur ou à

particulièrement importante dans les régions rurales.

Avertissement: L'utilisateur ne doit pas tenter de faire ces raccordements lui-même; il doit avoir recours à un service d'inspection des installations électriques, ou à un électricien, selon le cas.

AVIS: L'indice d'équivalence de la sonnerie (IES) assigné à chaque dispositif terminal indique le nombre maximal de terminaux qui peuvent être raccordés à une interface.

La terminaison d'une interface téléphonique peut consister en une combinaison de quelques dispositifs, à la seule condition que la somme d'indices d'équivalence de la sonnerie de tous les dispositifs n'excède pas 5. L'indice d'équivalence de la sonnerie de ce matériel est de 0.4.

Contents

<i>Welcome</i>	1
Features	1
Unpacking Your Notebook	3
Manuals	3
Recovery CDs	4
Software CDs	4
Other	4
<i>Using Your Notebook</i>	5
Locating Controls and Connectors.....	5
Front.....	5
Left	6
Right.....	7
Back	7
Bottom.....	8
Connecting a Power Source	9
Using the AC Adapter.....	9
Using Battery Power.....	9
Starting Your Computer	13
Shutting Down Your Computer	14
Registering Your Computer	15
Using the Keyboard.....	16
Combinations and Functions with the Windows Key	17
Indicators.....	18
Combinations and Functions with the Fn Key	19
VAIO Action Setup.....	21
Programmable Power Keys.....	21
Internal Timer	21
Using the Touchpad	22

Using the Floppy Disk Drive	23
Using the CD-ROM	25
Using PC Cards	27
Using Smart Connect	30
Using Infrared Communication Devices	31
Using Power Saving Modes.....	33
Normal Mode	33
System Idle Mode	33
System Suspend Mode	34
System Hibernation Mode.....	34
Using a Second Battery Pack	35
Using the Weight Saver	37
<i>Connecting Peripheral Devices</i>	<i>39</i>
Connecting a Phone Line	40
Connecting the Port Replicator	41
Connecting a Printer	45
Connecting an External Display.....	46
Connecting an External Mouse or Keyboard	48
Connecting External Speakers.....	49
Connecting an External Microphone.....	50
Connecting a Digital Video Camera Recorder.....	51
Connecting a Universal Serial Bus (USB) Device	52
<i>Troubleshooting</i>	<i>53</i>
Power Management.....	59
Using the System and Application Recovery CDs.....	60
Using the System Recovery CD(s).....	60
Using the Application Recovery CD(s).....	62
<i>Adding Memory.....</i>	<i>63</i>
Specifications	66
<i>Index.....</i>	<i>69</i>

Welcome

Congratulations on your purchase of the Sony VAIO® notebook. Sony has combined leading-edge technology in audio, video, computing, and communications to provide you with state-of-the-art personal computing.

Features



For a complete description of the specifications of your VAIO® notebook, see page 66.

- **Exceptional performance:** Your notebook includes a fast Intel® Pentium® III processor and a V.90 compatible modem.*
- **Portability:** The rechargeable battery pack provides hours of use without AC power.
- **Sony audio and video quality:** High-quality MPEG1 video, which supports full-screen display and enables you to take advantage of today's advanced multimedia applications, games, and entertainment software.

* Actual upload and download speeds may vary due to line conditions, ISP support, and government regulations.

- **Multimedia features:** Enjoy the stereo speakers or use headphones (not supplied) to listen to audio and video CDs.
- **Microsoft® Windows® operating system:** Your system comes with Microsoft® Windows® 98 Second Edition.
- **Communications:** Access popular online services, send e-mail, browse the Internet, and use fax features.
- **CD-ROM:** Your system comes equipped with a built-in 24X (maximum) CD-ROM drive.*

* Data on a CD-ROM is read at a variable transfer rate, ranging from 10.3X at the innermost track to 24X at the outermost track (the data transfer standard 1X rate is 150 kbytes/s). The average data transfer rate is 17.2X or 2580 kbytes/s.

Recovery CDs

- ❑ System Recovery CD(s)
- ❑ Application Recovery CD(s)

Software CDs

- ❑ Microsoft® Word® 2000

Other

- ❑ Setting up your VAIO® Notebook (poster)
- ❑ Packet containing special product offers

... 49, 49)

... (page 16)

... pad (page 22)

... left/right buttons (page 22)

Power indicator (page 10)

Battery 1 and 2 indicators (pages 11, 18)

Hard disk drive indicator (page 18)

Num Lock indicator (page 18)

Caps Lock indicator (page 18)

Scroll Lock indicator (page 18)



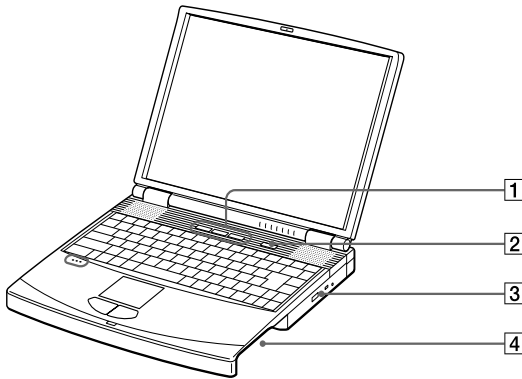



Right

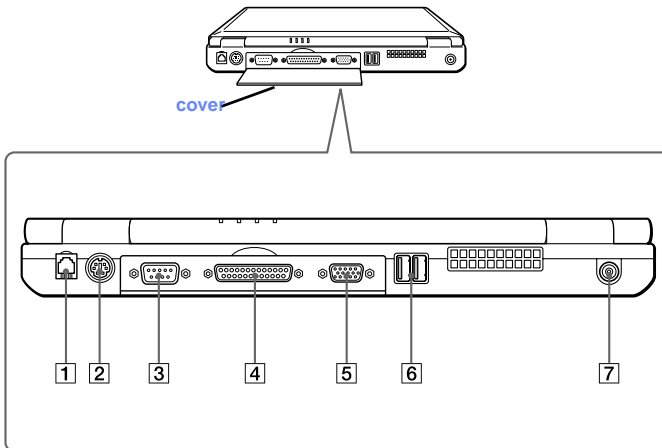

- | | |
|--|--|
| <p>1 PPK buttons (see the online document <i>Customizing Your VAIO® Notebook</i> for information on use)</p> <p>2 Power button</p> | <p>3 CD-ROM drive (page 25)</p> <p>4 Multipurpose drive bay (pages 23, 35, 37)</p> |
|--|--|

Back



- | | |
|--|---|
| <p>1 Modem jack (page 40)</p> <p>2  Mouse/Keyboard connector (page 48)</p> <p>3  Serial connector</p> <p>4  Printer connector (page 45)</p> | <p>5  Monitor connector (page 46)</p> <p>6  USB connectors (page 52)</p> <p>7  DC In connector (page 9)</p> |
|--|---|



There is a ventilation slot located between the USB connector and the DC In connector. Do not cover the ventilation slot when your computer is on.

Bottom

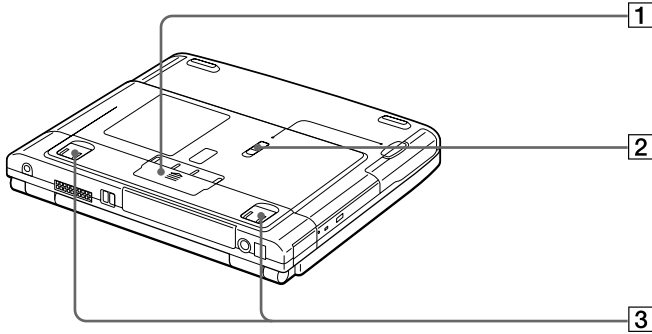

1 Port replicator connector cover (pages 42, 44)

3 Tilt stands

2 Multipurpose drive bay RELEASE lever (pages 36, 38)

Connecting a Power Source

You can use either AC power or a rechargeable battery pack as a power source.

Using the AC Adapter

1. Plug the cable attached to the AC adapter into the DC In connector on the computer.
2. Plug one end of the power cord into the AC adapter.
3. Plug the other end of the power cord into an AC outlet.

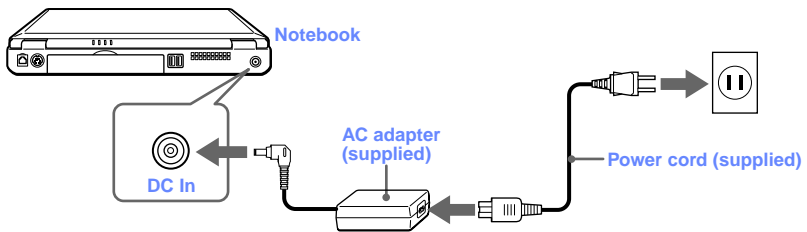

Using Battery Power

You can use one or two battery packs as a source of power. The second battery pack inserts into the multipurpose drive bay on the right side of the computer. (See “Using Power Saving Modes” on page 33.) Additional battery packs are available as a separate option.

The battery pack that comes with your computer is not fully charged at the time of purchase. Follow the steps below to insert and charge the battery pack.

To insert the battery pack

1. Open the cover of the battery bay.

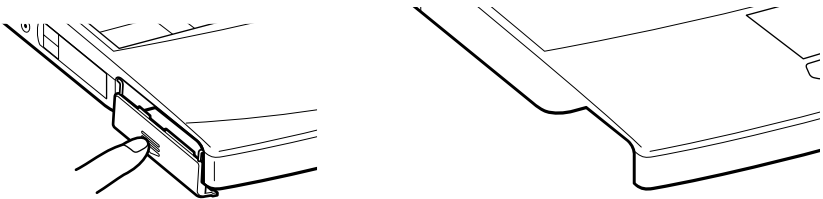

2. Insert the battery pack into the battery bay on the left side of the computer.

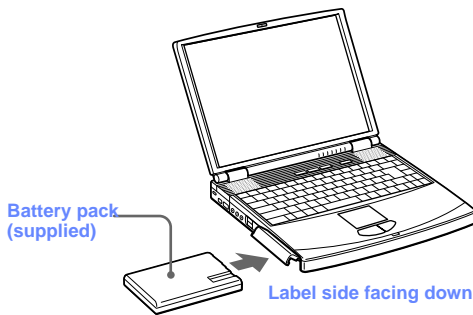

3. Close the cover of the battery bay until it clicks.



When attaching your computer to the port replicator, do not attempt to insert or remove the battery pack. Lifting and turning the computer with a port replicator attached could cause a temporary loss of power.



To charge the battery pack

1. Connect the AC adapter to the computer.
2. Insert the battery pack.

The computer automatically charges the battery (the battery indicator light flashes in a double-blink pattern as the battery charges). When the battery is 85 percent full, the battery indicator light turns off. This process takes approximately two hours. To charge the battery completely, continue charging for an additional hour. See “Displaying Detailed Battery Information” in the online document *Customizing Your VAIO® Notebook* for information on checking the battery life.

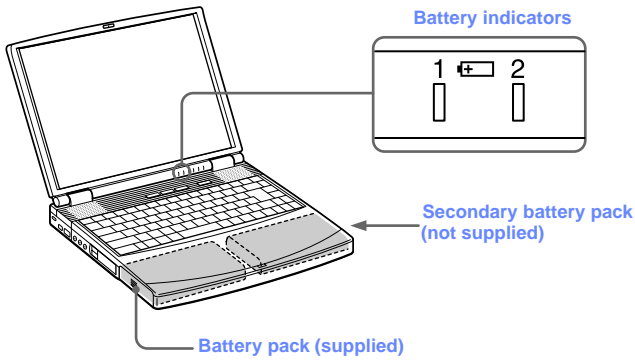
There are two battery indicator lights on the computer:



<i>Battery Indicator</i>	<i>Meaning</i>
1 	Indicates the status of the battery pack in the battery bay on the left side of the computer.
 2	Indicates the status of the battery pack in the multipurpose drive bay on the right side of the computer.

<i>Battery Indicator Light Status</i>	<i>Meaning</i>
On	The computer is using battery power.
Single blink	The battery is running out of power.
Double blink	The battery is charging.
Off	The computer is using AC power.



To
In
ba
W
ba
Se
ch
K
ba
If
re
Yo
Po
Th
re
lif
Th
W
Fo
er
us
po

To remove

1. Open
2. Pull o



3. Close the cover of the battery bay.



You may lose data if you remove the battery pack while the computer is on and not connected to the AC adapter or if you remove the battery while the computer is in System Suspend mode.

Starting Your Computer

1. Slide the LCD lock lever in the direction of the arrow, and lift the cover.

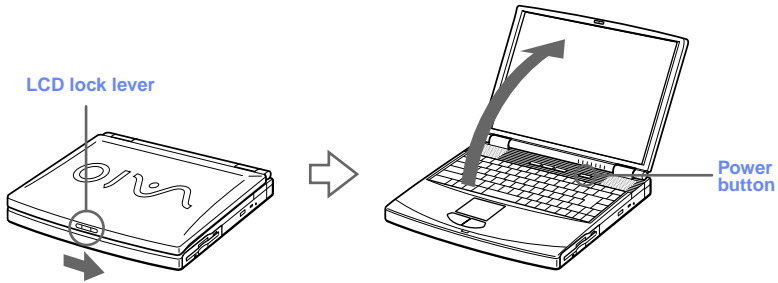

2. Press the power button on top of the computer until the green power indicator light turns on.

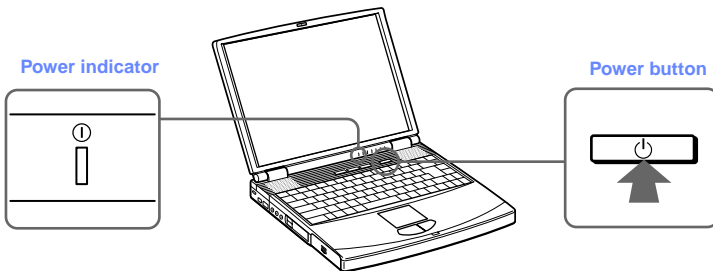

If you hold the power button in the On position for more than four seconds, the computer turns off.

3. If necessary, adjust the brightness controls for the LCD display. To decrease the brightness, press Fn+F5 and then the down or left arrow key. To increase the brightness, press Fn+F5 and then the up or right arrow key.

Shutting Down Your Computer



To avoid potential loss of data, follow these steps to shut down your computer.

1. Click the Start button on the Windows® taskbar.
2. Click Shut Down at the bottom of the Start menu to display the Shut Down Windows dialog box.

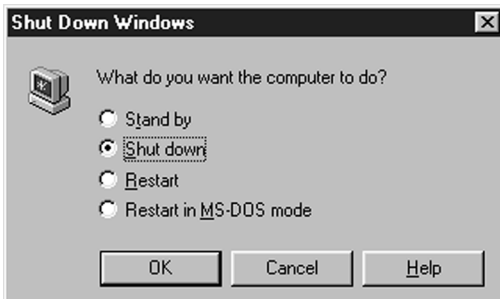

3. Select Shut down.
4. Click OK.



Respond to any prompts warning you to save documents.

5. Wait for your computer to turn off automatically. The power indicator (green) turns off.
6. Turn off any peripherals connected to your computer.





If you are unable to shut down your computer using the steps described above, press the Ctrl+Alt+Delete keys at the same time to restart the computer. If you are unable to restart the computer in this way, you can press the power button and hold it for four seconds. This operation may result in data loss.









During a period of inactivity, you can conserve battery life by using System Suspend mode. See "Controlling Power Management" in the online document *Customizing Your VAIO® Notebook*.





Investigation

<i>Key</i>	<i>Description</i>
Operator keys	Several keys are always used with at least one other key: Ctrl, Alt, and Shift. When held down with another key, the Ctrl (Control) and Alt (Alternate) keys offer another way to give commands. For example, in many applications, instead of choosing the Save command from a menu, you can hold down Ctrl and press S (referred to as Ctrl+S). The Shift key operates the same way as on a typewriter; it is used to produce capital letters or special symbols such as @ and \$.
Windows key 	The key with the Windows logo displays the Windows Start menu; it is the equivalent of clicking the Start button on the taskbar. See "Combinations and Functions with the Windows Key" on page 17.
Fn key	The Fn key is used in combination with other keys to issue commands. See "Combinations and Functions with the Fn Key" on page 19.
Applications key 	The Applications key displays a shortcut menu of context-sensitive choices. Pressing this key is the equivalent of clicking the right mouse button.

Combinations and Functions with the Windows Key

<i>Combination</i>	<i>Function</i>
 + F1	Displays Windows Help.
 + Tab	Switches the selected button on the taskbar.
 + E	Displays Windows Explorer.
 + F	Displays the Windows Find: All Files window to find a file or folder. This is the equivalent of selecting Find and then Files or Folders from the Start menu.
 + Ctrl + F	Displays the Windows Find: Computer window where you can locate other computers. This is the equivalent of selecting Find and then Computer from the Start menu.
 + M	Minimizes all displayed windows.
Shift +  + M	Returns all minimized windows to their previous size.
 + R	Displays the Run window. This is the equivalent of selecting Run from the Start menu.
Fn +  + Insert	Displays the Properties window. This is the equivalent of double-clicking the System icon in the Control Panel.

Indicators

<i>Indicator</i>	<i>Function</i>
Power ①	Light is green when the power to the computer is turned on. Light is red in System Idle mode, and flashes red in System Suspend mode. The light turns off when the computer is in System Hibernation mode or powered off.
Battery 1 1 	Indicates the status of the battery inserted in the battery bay on the left side of the computer.
Battery 2  2	Indicates the status of the battery inserted in the multipurpose drive bay on the right side of the computer.
Hard disk 	Lights when data is being read from or written to the hard drive. Do not enter System Suspend mode or turn off the computer when this indicator light is on.

<i>Light</i>	<i>On</i>	<i>Off</i>
Num Lock	The number keys in the numeric keypad are active.	The alphanumeric character keys in the keypad area are active.
Caps Lock	The letters appear in uppercase as you type. The Shift key lowers the case of typed letters when Caps Lock is on.	Letters appear in lower case as you type (unless you hold down the Shift key).
Scroll Lock	The screen scrolls differently. (Exactly how it scrolls depends on the specific application. It has no effect in many applications.)	Information moves across the display normally.

Combinations and Functions with the Fn Key

Combinations/ Feature

Function

Fn+  (ESC)
System Suspend

Puts the system into System Suspend mode, a power-management state. To return the system to the active state, press any key or press the power button on your computer.

Fn+  (F2)
Display power source status

Displays the power source status, as in the example below:



Using AC
power



Charging a
battery pack

Fn+  (F3)
Mute On/Off

Toggles the built-in speaker off and on.

Fn+  (F4)
Speaker volume

Adjusts the built-in speaker volume.

To increase volume, press Fn+F4, then **↑** or **→**.

To decrease volume, press Fn+F4, then **↓** or **←**.

Fn+  (F5)
Brightness control



Adjusts the brightness of the LCD.

To increase light intensity, press Fn+F5 and then **↑** or **→**.

To decrease light intensity, press Fn+F5 and then **↓** or **←**.



Fn+  (F6)
Contrast control

Adjusts the screen contrast.

Fn+  /  (F7)
Switch to the
external monitor/LCD

Toggles through the LCD, external display (connected to the  Monitor connector) and both LCD and external display.



Fn+  only/
 (F8)
Control TV out

Toggles between LCD-only and dual LCD/TV display modes.

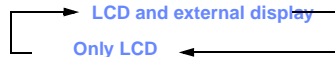

Fn+ (F12) System Hibernation	Provides for the lowest level of power consumption. When you execute this command, the state of the system and state of the peripheral devices are written to the hard disk and the system power is turned off. To return the system to its original state, use the power button to turn on power.
Fn+D Video standby	Turns off the LCD to save power. To turn the LCD back on, press any key.
Fn+F Change the display size	Zooms the display size in or out when the display is set to a low resolution.
Fn+S System Idle	Puts the system into System Idle mode, a power- management state. To return the system to the active state, press any key.



VAIO Action Setup

VAIO Action Setup manages the settings for your computer's Programmable Power Keys (PPK), and internal timer. An overview of each of these functions is provided below. For more information on changing the settings using VAIO Action Setup, from the Start menu, go to Programs, VAIO Action Setup, VAIO Action Setup.

Programmable Power Keys

Your Sony computer comes with technology that allows you to access your favorite applications easily. The three Programmable Power Keys (PPK) at the top of your keyboard are shortcut buttons that can be programmed to carry out a variety of computer operations automatically. If you wish, you can use the VAIO Action Setup software to change the Programmable Power Keys' preset functions. See the online document *Customizing Your VAIO® Notebook* for details.

Internal Timer

The VAIO Action Setup software allows you to set your computer's internal timer to launch certain applications automatically. The timer can start applications even when the computer is in the System Hibernation Mode.



Using the Touchpad

The keyboard contains a cursor-pointing device called a touchpad. You can use the touchpad to point to, select, drag, and scroll objects on the screen using the built-in touchpad.

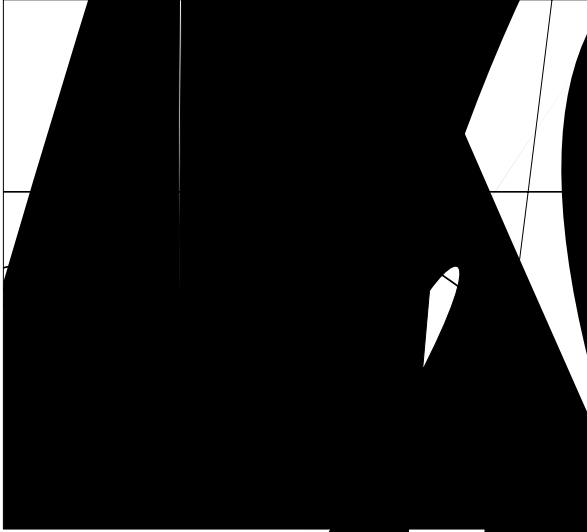

Action	Description
Point	Slide one finger across the touchpad to point to an object on the screen.
Click	Press the touchpad to select an object on the screen.
Double-click	Press the touchpad twice to open a folder or application.
Right-click	Press the touchpad with two fingers. In many applications, right-clicking is sensitive to the direction of the touch. In some applications, right-clicking is sensitive to the position of the touch. In many applications, right-clicking is sensitive to the position of the touch.
Drag	Press and hold the touchpad, then move the touchpad to drag an object on the screen.
Scroll	Press and hold the touchpad with two fingers, then move the touchpad to scroll through a document or application.

When you touch the touchpad with two fingers, the touchpad is sensitive to the direction of the touch. In many applications, right-clicking is sensitive to the position of the touch. In some applications, right-clicking is sensitive to the position of the touch.

When you touch the touchpad with two fingers, the touchpad is sensitive to the direction of the touch. In many applications, right-clicking is sensitive to the position of the touch. In some applications, right-clicking is sensitive to the position of the touch.

When you touch the touchpad with two fingers, the touchpad is sensitive to the direction of the touch. In many applications, right-clicking is sensitive to the position of the touch. In some applications, right-clicking is sensitive to the position of the touch.

Using the Floppy Disk Drive

The computer comes with the floppy disk drive in the multipurpose drive bay.

To insert a diskette

1. Hold the diskette with the label side facing up.
2. Gently push the diskette into the drive until it clicks into place.

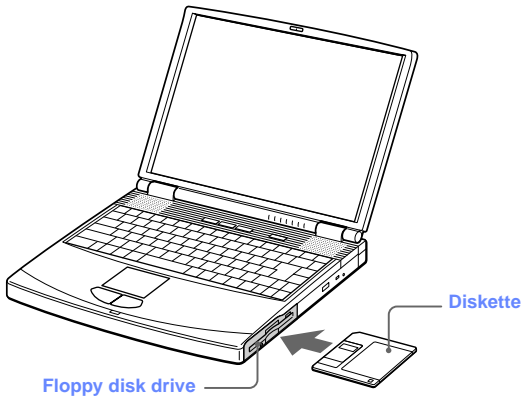

To remove a diskette

- When you finish using the diskette, wait until the LED indicator light turns off and then press the Eject button to remove the diskette.

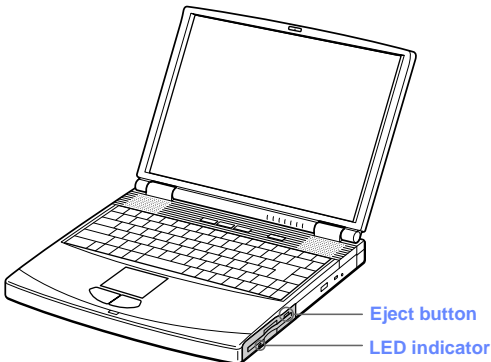

Do not press the Eject button when the LED indicator is turned on. Otherwise, data may be lost.

To remove the floppy disk drive

1. Turn off the computer.
2. There is a RELEASE lever on the bottom of the computer. Slide this lever in the direction of the arrow.

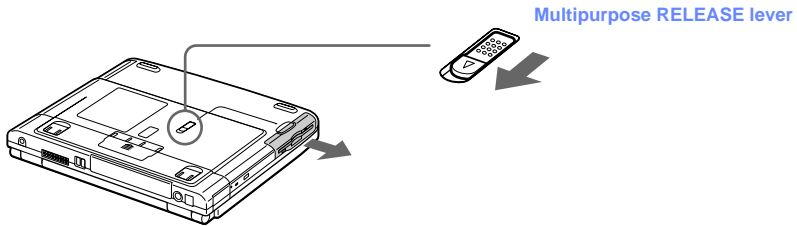

3. Slide the drive out of the multipurpose drive bay.
4. Insert the weight saver. See "Using the Weight Saver" on page 37.

To reinsert the floppy disk drive

1. Turn off the computer.
2. If another device is in the multipurpose drive bay, remove the device as shown above, or see "To remove the second battery pack" on page 36.
3. Insert the floppy disk drive into the multipurpose drive bay with the VAIO label facing up. Continue pushing the drive into the bay until the RELEASE lever locks into place.

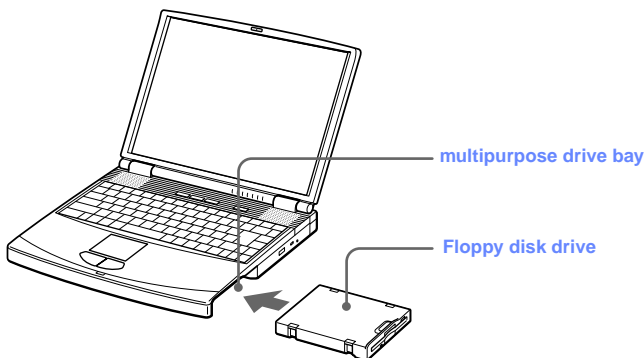

Using the CD-ROM

Your computer comes with a CD-ROM.

To insert a disc

1. Turn on the computer.



When the computer is in System Suspend or System Hibernation mode, you cannot insert a disc. See "Controlling Power Management" in the online document *Customizing Your VAIO® Notebook* for more information on System Suspend and System Hibernation modes.

2. Press the Eject button to open the CD-ROM drive.
The tray slides out.

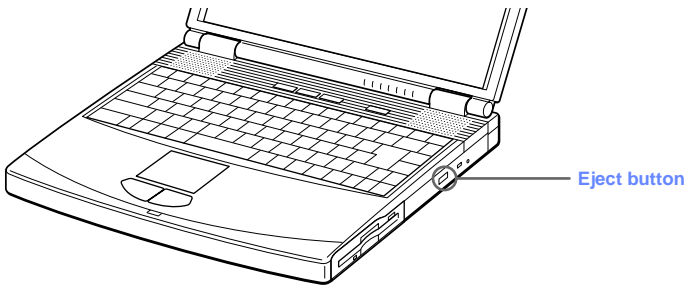

3. Place a CD-ROM in the tray with the label side facing up. Push the disc onto the hub until the disc clicks into place.

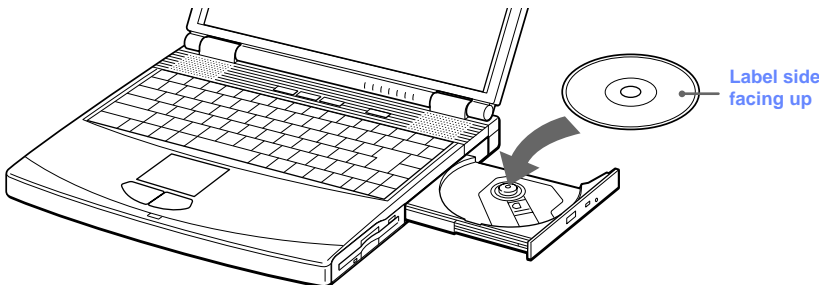

4. Close the tray by pushing it gently.



Be sure to seat the disc firmly over the hub fingers. If you do not seat the disc firmly, you could damage your CD-ROM drive and you may not be able to open the tray. When you finish using a disc, wait until the LED indicator light turns off. Then, press the Eject button to remove the disc.

When the computer is in System Suspend or System Hibernation mode, you cannot remove a disc. See "Controlling Power Management" in the online document *Customizing Your VAIO® Notebook* for more information about System Suspend and System Hibernation modes.

If the disc does not come out when you press the Eject button, turn off the computer and insert a thin, pointed object into the manual eject hole.

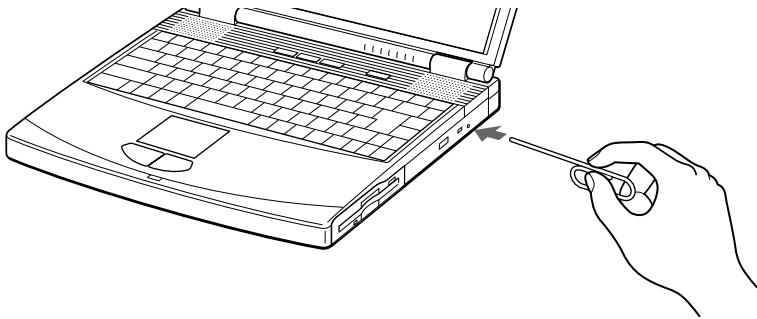

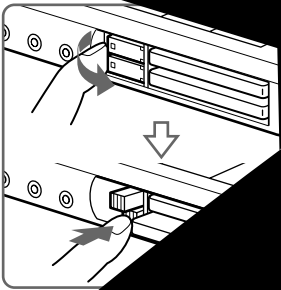

2. Remove the PC card slot protector.

When you use a Type III PC card, you need to remove both the top and bottom PC card slot protectors.

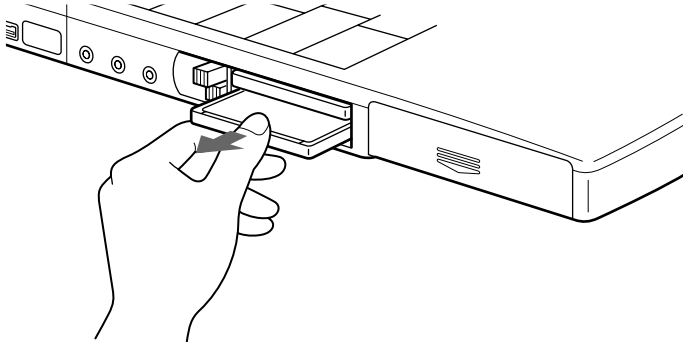

3. Insert the PC card into the PC card slot, front label facing up. Gently push the card into the slot until the card is fixed into the connector. The release button comes out.

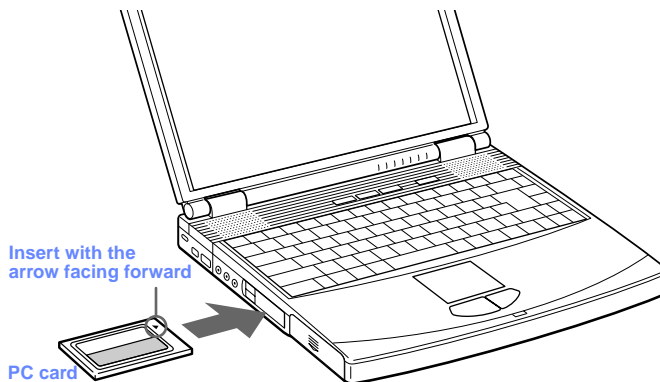

Do not force a card into the slot as this may damage the connector pins. If you have difficulty inserting a card, check that you are inserting the card with the correct orientation. See the manual that came with your PC card for more information on use. For some PC cards, if you alternate between normal power operation and the System Suspend or System Hibernation power-management modes while the card is inserted, you may find that a device connected to your system is not recognized. Reboot your system to correct the problem.

To remove a PC card

1. Close any applications that are using the PC card.
2. Click the PC card icon in the taskbar and close the card window.
3. Pull the PC card release button up and press it in toward the computer.
4. Gently grasp the card and pull it out.
5. Insert the PC card slot protector back into the empty slot.

Using Smart Connect

The preinstalled Smart Connect software allows you to use an i.LINK® cable (not supplied) to connect your VAIO notebook to another VAIO computer that also has Smart Connect. You can then use one computer to copy, delete, and edit files on the other computer. You can also print from a printer attached to either computer.



When you use Smart Connect to connect two VAIO computers, you must assign each computer a unique name by which it can be identified when the two computers are networked.

See the Smart Connect online help for more information.

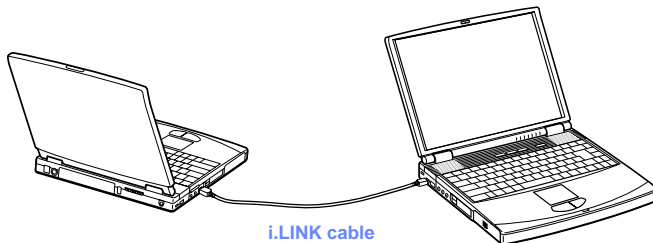

i.LINK cables compatible with your VAIO notebook include cables with the following part numbers: VMC-IL4415 (a 1.5-meter cable with a 4-pin connector at each end), VMC-IL4615 (a 1.5-meter cable with a 4-pin connector at one end and a 6-pin connector at the other), and VMC-IL4408A (a 0.8-meter cable with a 4-pin connector at each end).

Using Infrared Communication Devices

Your computer includes an infrared port, located on the left side. You can use this port to communicate with other infrared-equipped devices with compatible protocols, such as a digital still camera or other computers.

To use infrared communication with another computer

Align the infrared ports on the two computers so that they are in a direct line.

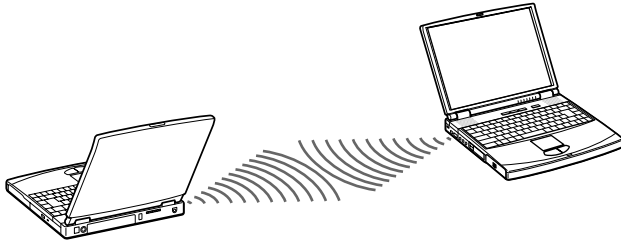



Infrared communication capability can be turned on and off. By default, it is not enabled when your system is shipped. To enable infrared use, click the infrared icon in the Windows Control Panel and select the Enable infrared communication check box on the Options tab.

You can disable infrared communication when you are not using it to conserve battery life.

Use the infrared icon in the Windows Control Panel to enable and disable infrared communication. Do not use the icon in the taskbar.

Check the Status tag of the Infrared Monitor in the Windows Control Panel to determine if the infrared device is detected.

If the two devices are too far apart or too close together, data transfer may be interrupted or there may be noise in the transmission.

Do not cover the infrared ports with your hand or any other object.

Avoid direct sunlight, fluorescent light, or flashing incandescent light near the infrared ports.

The active area of infrared transmission extends about $39\frac{3}{8}$ inches (1 meter) with a radius of approximately 15 degrees.

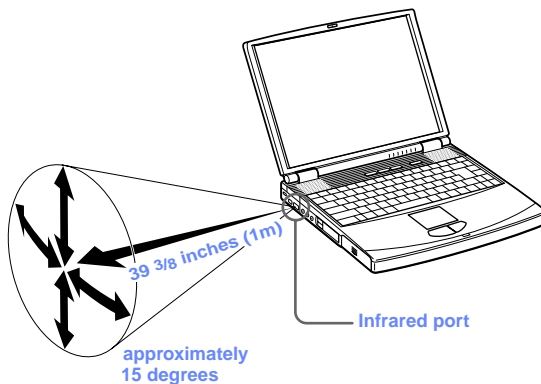

Using Power Saving Modes

System Suspend Mode

The computer saves the current state of the system in RAM and switches off power to the CPU. The amber power indicator light flashes in this mode.

To activate System Suspend mode

Press Fn+Esc, or press the power button and release it immediately. You can also use the PowerPanel utility to enter System Suspend mode.

To return to normal mode

Press any key.

System Hibernation Mode

The state of the system is saved on the hard drive and power is turned off. The power indicator light is off in this mode.

To activate System Hibernation mode

Press Fn+F12. The “Save to Disk Manager” screen appears, and then the computer enters System Hibernation mode. You can also use the PowerPanel utility to enter System Hibernation mode.

To return to normal mode

Turn on the computer by pressing the power button. The computer returns to its previous state.



When returning from System Hibernation mode, the system status stored on the hard disk is erased and the computer starts normally if you press the power button and hold for more than four seconds.

- Time to return to normal mode
System Idle requires less time than System Suspend, and System Suspend requires less time than System Hibernation.
- Power consumption
System Idle uses more power than System Suspend, and System Suspend uses more power than System Hibernation.

Using a Second Battery Pack

You can purchase a second rechargeable battery pack. With two battery packs, you can extend the time that you use your computer with battery power. When using two battery packs, the battery pack you insert first charges first. The battery pack you insert second charges when the first battery pack is 85 percent full. You can monitor which battery pack is charging by observing the battery indicator lights.

To insert a second battery pack

1. If another device is in the multipurpose drive bay, remove the device. See "To remove the floppy disk drive" on page 24.
2. Insert the battery pack into the multipurpose drive bay. If the battery is being used, the battery 2 indicator light turns on.

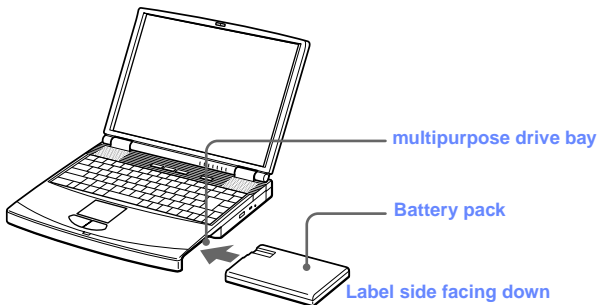

3. Attach the weight saver to the computer to stabilize the battery pack. There is a RELEASE lever on the bottom of the weight saver. Slide the lever toward the front of the computer to lock the weight saver. See also "Using the Weight Saver" on page 37.

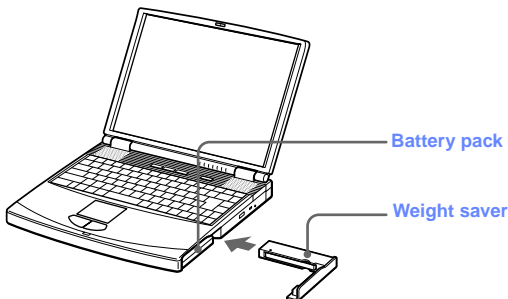

To charge the second battery pack

Keep the battery pack in the computer while it is connected to AC power. The battery indicator flashes while the battery is charging. See also “To charge the battery pack” on page 10 for more information.

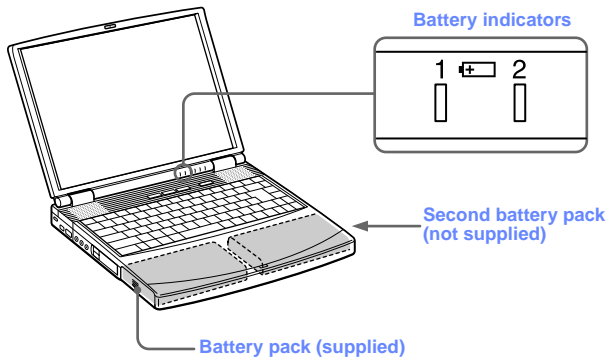

To determine the amount of time the battery lasts, see “Displaying Battery Information” in the online document *Customizing Your VAIO® Notebook*.

To remove the second battery pack

If you attach two battery packs, you can remove either of them without shutting down the computer. When removing one battery pack, make sure that the other battery pack’s indicator light is on. If the indicator light of the battery pack you are removing is on, right-click the battery icon on the task bar and click the “Switch discharge battery” option.

1. There is a Release lever on the bottom of the weight saver. To remove the battery pack, slide this lever in the direction of arrow 1, and then slide the RELEASE lever on the bottom of the computer in the direction of arrow 2.

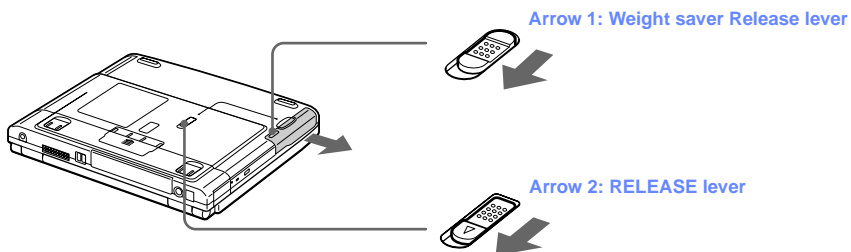

2. Remove the weight saver, and then pull out the battery pack.
3. Reinsert the weight saver. See “Using the Weight Saver” on page 37.

Using the Weight Saver

The weight saver protects the multipurpose drive bay when it is empty.

To attach the weight saver

1. If another device is in the multipurpose drive bay, remove the device. See "To remove the floppy disk drive" on page 24 or "To remove the second battery pack" on page 36.
2. Fold out the hinged arm of the weight saver and then push on the hinged arm to lock it into place. Slide the weight saver in the direction of the arrow until it clicks.

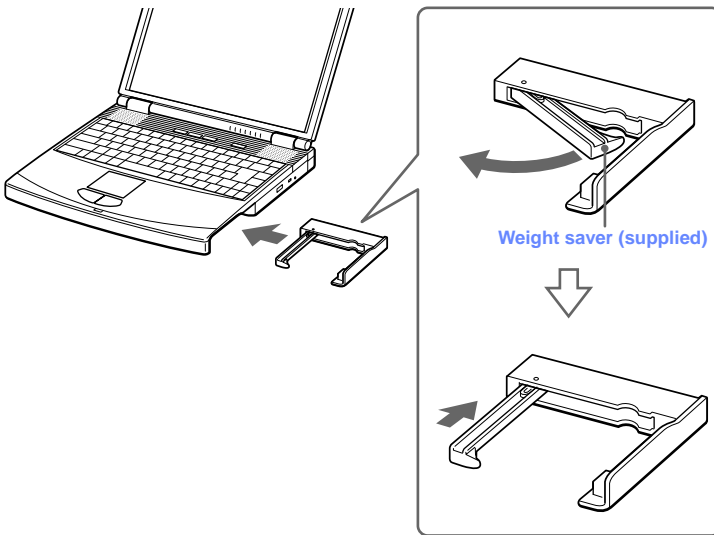

3. Manually lock the weight saver's Release lever.

To remove the Weight Saver

1. There is a release lever on the bottom of the weight saver. To remove the weight saver, slide this lever in the direction of arrow 1, then slide the Release lever on the bottom of the computer in the direction of arrow 2.

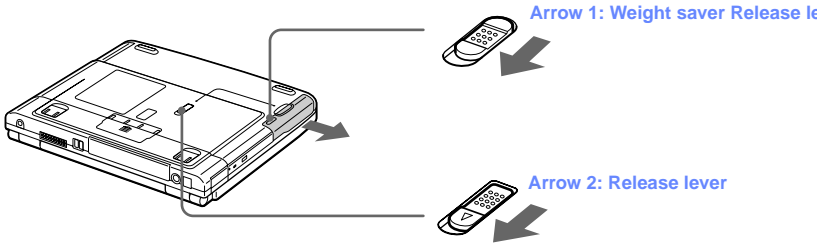

2. After removing the weight saver, pull out the weight saver's hinged arm and fold it into the weight saver.

Connecting Peripheral Devices

You can add functionality to your computer by connecting any of these peripherals:

- ❑ Phone line (page 40)
- ❑ Port replicator (page 41)
- ❑ Printer (page 45)
- ❑ External display (page 46)
- ❑ External mouse or keyboard (page 48)
- ❑ External speakers (page 49)
- ❑ External microphone (page 50)
- ❑ Digital video camera recorder (page 51)
- ❑ Universal Serial Bus (USB) device (page 52)



Before you connect peripherals, turn off the computer and all peripherals. You do not need to turn off your computer to connect USB devices. Connect the power cord only after connecting all cables. Turn on the computer only after turning on all peripherals.

Connecting the Port Replicator

Your notebook supports the use of an optional port replicator (PCGA-PRF1A). Attaching a port replicator enables you to connect additional peripherals to your computer.

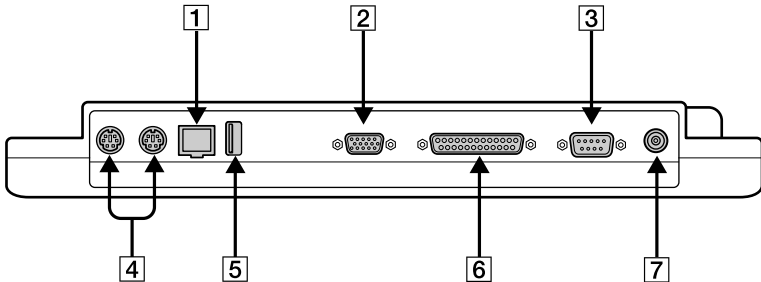

1  Network (Ethernet)

2  Monitor (page 46)

3  IOIO Serial

4  Mouse/Keyboard (page 48)

5  USB (page 52)

6  Printer (page 45)

7  DC In (page 9)



The port replicator can be powered only with an AC power adapter. Do not remove the AC adapter from the port replicator or the AC outlet while using the port replicator; this may cause data damage or hardware malfunctions. When you attach your computer to the port replicator for the first time, the installation of the network driver starts automatically.

To attach your computer to a port replicator

To supply power to the computer while it is connected to the port replicator, you can connect the power adapter directly to the port replicator.

- 1 When connecting your computer to the port replicator, do not attempt to insert or remove the battery pack. Lifting and turning the computer with an attached port replicator can cause a temporary loss of power.

2 Turn off your computer and disconnect all peripherals.

3 At the bottom of the computer, slide the port replicator connector cover open.

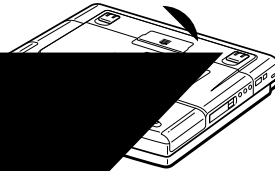

4 Push the port replicator connector until it

4. Plug the cable attached to the AC adapter into the **DC IN** connector on the port replicator. Plug the power cord into the AC adapter and an AC outlet.

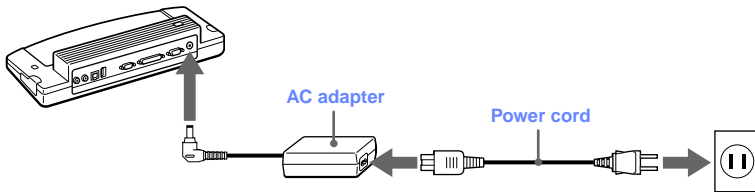

Use the AC adapter that comes with your computer.

The power indicator light turns green.

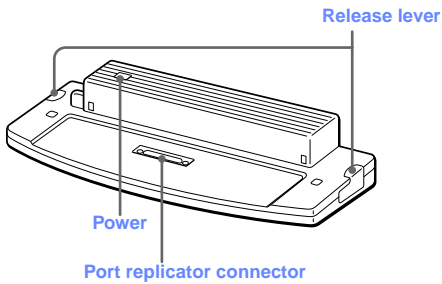

5. Turn on the computer.

To remove your computer from the port replicator when the power is off

1. Turn off your computer and the connected peripherals.
2. Pull the levers on each side of the port replicator to disengage the computer from the port replicator.

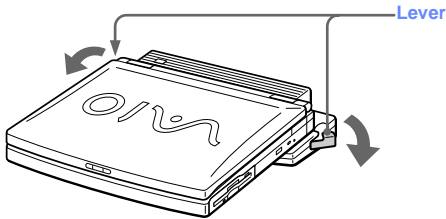

3. Lift the computer away from the port replicator.

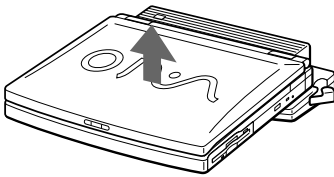

4. Close the port replicator connector cover on the bottom of your computer.



It is extremely important to close the port replicator connector cover after removing your computer from the port replicator. If the cover is left open, dirt may get inside and damage the computer.

Connecting a Printer

You can connect your computer to a printer that is compatible with Windows® 98.

To connect a printer

- Use the  symbol to locate the Printer connector. Plug the printer cable (supplied with the printer) into this port on the computer.

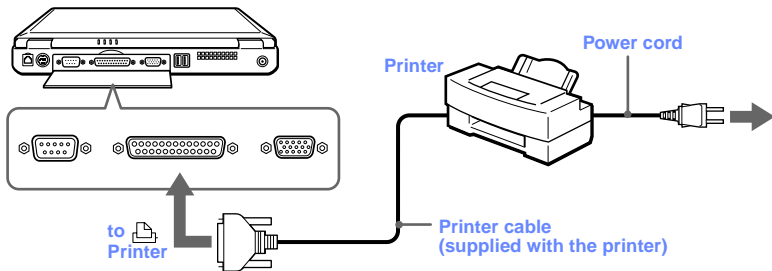

See the manual that came with your printer for more information on installation and use.

If your printer stops functioning after resuming from a power-saving mode, see "I cannot print" on page 58.

Before using the printer, you may need to change the Printer setting in the Sony Notebook Setup software. See "Displaying the Sony Notebook Setup Screen" in the online document *Customizing Your VAIO® Notebook*.

Connecting an External Display

You can connect an external display to your notebook. For example, you can use the computer with any of the following:

- Computer display (monitor) (page 46)
- Multimedia computer display (page 46)
- Projector (page 47)

To connect a computer display

- Use the □ symbol on the back of the computer to locate the Monitor connector. Plug the display cable (not supplied) into this connector on the back of the computer.
- If necessary, plug one end of the display power cord into the display, and the other end into an AC outlet.

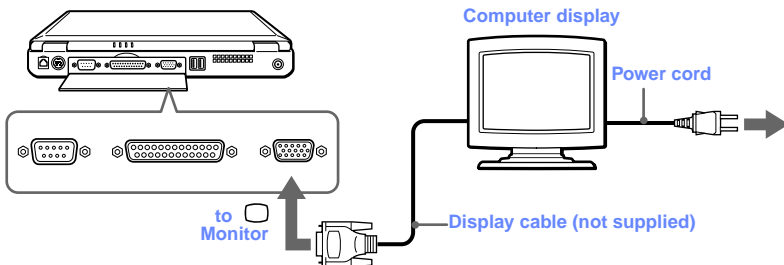

See the manual that came with your computer display for more information on installation and use.

To connect a multimedia computer display

You can connect the notebook to a multimedia computer display that includes built-in speakers and a microphone.

1. Use the □ symbol to locate the Monitor connector. Plug the display cable into this connector.
2. Use the 🎧 symbol to locate the Headphone connector. Plug the speaker cable into this connector.
3. Use the 🎤 symbol to locate the Microphone connector. Plug the microphone cable into this connector.



See the manual that came with your multimedia computer display for more information on installation and use.

To connect a projector

You can use a projector, such as the Sony LCD Projector, as an external display.

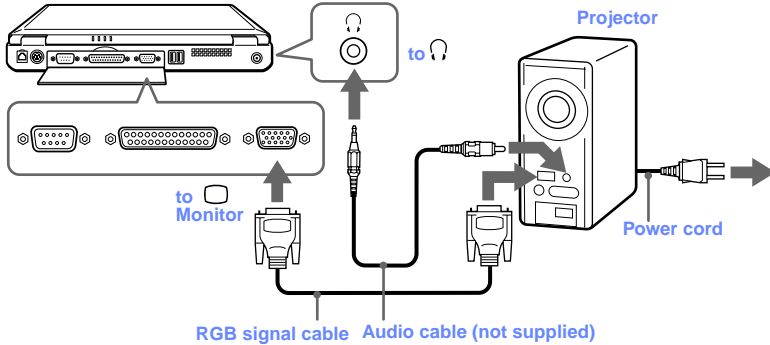

See the manual that came with your projector for more information on installation and use.

To select a display

When you connect an external display to the monitor connector, you can toggle the output between the Liquid Crystal Display (LCD), the external monitor, or both devices.

Use the Fn+F7 keys to select a display. See also “Selecting the Display Mode” in the online document *Customizing Your VAIO® Notebook* for more information.

To	Press	Result
Switch to an external display	Fn+F7	Toggles between the LCD, the external display connected to the Monitor connector, or both the LCD and external display.

```

graph LR
    A[Only LCD] --> B[LCD and external display]
    B --> C[Only external display]
    C --> A
  
```

Connecting an External Mouse or Keyboard

You can connect a PS/2® style mouse or keyboard.

Plug the keyboard cable or mouse cable into this connector with the  mark facing up.

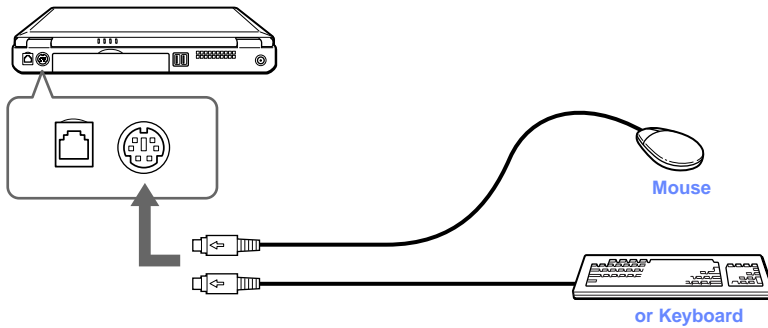

To connect both a mouse and keyboard at the same time, use the optional PS/2 division connector.



See "Using the Keyboard" on page 16 for more information on using the keyboard.
See the manual that came with your mouse or keyboard for more information on installation and use.

Before you connect or disconnect the mouse or keyboard, turn off the computer.
Do not connect or disconnect the PS/2 device (keyboard or mouse) when the computer is on. It may cause malfunction.

The Sony USB mouse PCGA-UMS1 (not supplied) is a USB device. So you must connect it to the USB connector.

Connecting External Speakers

You can enhance the sound quality of your computer by connecting external speakers.



Make sure your speakers are designed for computer use.
Turn down the volume of the speakers before you turn them on.
Do not place diskettes on the speakers; the speakers' magnetic field may damage the data on the diskettes.

To connect external speakers

- Use the  symbol to locate the Headphone connector. Plug the speaker cable into this connector.

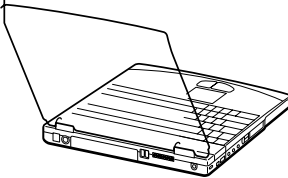

See the manual that came with your speakers for more information on installation and use.

Connecting an External Microphone

You can enhance the quality of sound input by using an external microphone.



Make sure your microphone is designed for computer use. The microphone should be compliant with the plug-in power microphone.

To connect an external microphone

- Use the  to locate the Microphone connector. Plug the microphone cable into this connector.

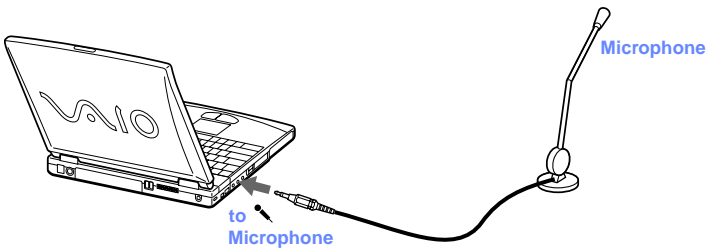

See the manual that came with your microphone for more information on installation and use.

Connecting a Digital Video Camera Recorder

You can connect an i.LINK-enabled digital video camera recorder to the S400 i.LINK port (IEEE1394) on the computer.

To connect a digital video camera recorder:

- Plug one end of the i.LINK cable (not included) into the i.LINK port on the left side of the computer and the other end into the i.LINK connector on the digital video camera recorder.

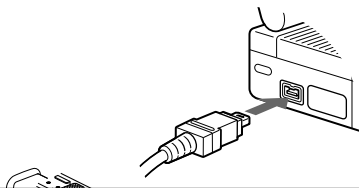

Connecting a Universal Serial Bus (USB) Device

You can connect a USB device to your computer.

To connect a USB device

- Use the  symbol to locate the USB connector. Plug one end of the USB cable into this port and the other end into the USB device.

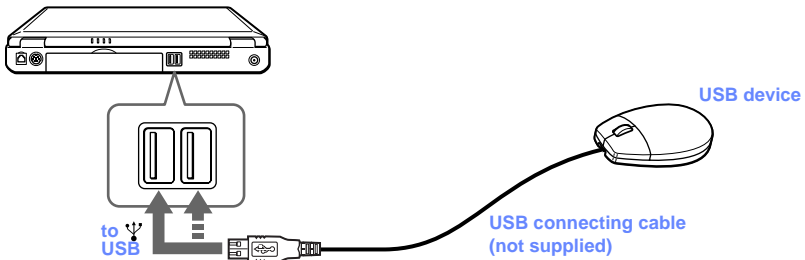

You can use the optional Sony USB mouse PCGA-UMS1 with this computer. The USB mouse software driver is preinstalled in the computer. Plug the USB mouse into the USB connector, and restart the computer. All necessary drivers will be loaded.



See the manual that came with your USB device for more information on installation and use.

Troubleshooting

This section describes how to solve common problems you may encounter when using your computer. Many problems have simple solutions, so try these suggestions before you contact Sony Customer Support (www.sony.com/pcsupport).



When you reconnect devices be sure to turn off the computer as described in “Shutting Down Your Computer” on page 14. Turning off the computer using other methods may result in data loss.

My computer does not start

- ❑ Check that the computer is plugged into a power source and that it is turned on. Check that the power indicator on the front panel of the computer indicates that the power is on.
- ❑ Check that the battery packs are inserted properly and that they are charged.
- ❑ Make sure there is no diskette in the floppy disk drive.
- ❑ Confirm that the power cord and all cables are connected firmly, as described in “Connecting Peripheral Devices” on page 39.
- ❑ If you plugged the computer into a power strip or UPS, make sure the power strip or UPS is turned on and working.
- ❑ If you are using an external display, check that it is plugged into a power source and turned on. Check that the brightness and contrast controls are adjusted correctly. See the manual that came with your display for details.
- ❑ Moisture condensation may have occurred. Do not use the computer for at least one hour and then turn on the computer.
- ❑ When the internal backup battery is low on power, it may not be able to start your system properly. The message “Press <F1> to resume, <F2> to setup” would appear at the bottom of the display. Should this happen, you need to initialize the BIOS. Follow steps 3 to 8 below.

When I turn on my computer, the message “Operating system not found” appears and Windows does not start

- ❑ Check the floppy disk drive to see if a non-bootable diskette is in the drive.
- ❑ If a non-bootable diskette is in the drive, turn off the computer, remove the diskette, and then turn on the computer again. Confirm that Windows starts properly. If Windows still does not start, follow the procedure below to initialize the BIOS.
- ❑ If the floppy disk drive is empty, follow the steps below to initialize the BIOS:
 1. Remove any peripheral devices connected to the computer.
 2. Turn the computer off and then turn it on again.
 3. Turn on the computer and press the F2 key when the Sony logo appears. The BIOS setup menu screen appears.
 4. Press the arrow keys to select the Exit menu.
 5. Press the arrow keys to select Get Default Values and then press the Enter key. The message “Load default configuration now?” appears.
 6. Check that Yes is selected, then press the Enter key.
 7. Press the arrow keys to select Exit (Save Changes) and then press the Enter key. The message “Save configuration changes and exit now?” appears.
 8. Check that Yes is selected, then press the Enter key. The computer restarts.

If your computer still displays the message “Operating system not found” and Windows does not start, contact Sony Customer Support.

My LCD does not display anything

- ❑ Check that the computer is plugged into a power source and that it is turned on. Check that the power indicator on the front panel of the computer is on.
- ❑ Check that the battery packs are inserted properly and that they are charged.
- ❑ The computer may be in LCD (Video) Standby mode. Press any key to activate the display.

The screen image on my external display is not centered or sized properly

Use the controls on your external display to adjust the image. See the manual supplied with your display for more information.

My computer "locks up"

My floppy disk drive cannot write to a diskette

- ❑ If the diskette is write-protected, disable the write-protect feature or use a diskette that is not write-protected.
- ❑ Check that the diskette is properly inserted into the floppy disk drive.

My speakers have no sound

- ❑ If the built-in speakers are turned off, press Fn+F3 to turn on the speakers.
- ❑ If the speaker volume is turned to the minimum, press Fn+F4, and then press **↑** or **→** to increase the volume.
- ❑ If your computer is powered by batteries, check that the battery packs are inserted properly and that they are charged.
- ❑ If you are using an application that has its own volume control, check that the volume is turned up.
- ❑ Check the volume controls in Windows 98.
- ❑ If you connect external speakers, check that the speakers are properly connected and the volume is turned up. If the speakers have a mute button, make sure it is off. If the speakers are powered by batteries, check that the batteries are inserted properly and that they are charged.
- ❑ If you have connected an audio cable to the Headphone connector, disconnect the cable.

My modem does not work

- ❑ Check that the phone line is plugged into the line jack. See “Connecting a Phone Line” on page 40 for details.
- ❑ Check that the phone line is working. You can check the line by plugging in an ordinary phone and listening for a dial tone.
- ❑ Check that the phone number the program is dialing is correct.
- ❑ Check that the software you are using is compatible with the notebook modem. (All preinstalled programs are compatible.) Call the software publisher or Sony Customer Support.

My modem connection is slow

The computer's modem uses V.90 technology. Many factors influence modem connection speed, including telephone line noise or compatibility with telephone equipment (such as fax machines or other modems). If you think your modem is not connecting properly to other PC-based modems, fax machines, or your Internet Service Provider, check the following:

- ❑ Have your phone company check that your phone line is free from any line noise.
- ❑ If your problem is fax-related, check that there are no problems with the fax machine you are calling and that it is compatible with fax modems.
- ❑ If you are having a problem connecting with your Internet Service Provider (ISP), check that the ISP is not experiencing technical problems.
- ❑ If you have a second phone line available, try connecting the modem to that line.

My microphone does not work

If you are using an external microphone, check that the microphone is plugged into the Microphone connector. See “Connecting an External Microphone” on page 50 for details.

My mouse does not work

- ❑ If you are using an external mouse, check that the mouse is plugged into the mouse connector. See “Connecting an External Mouse or Keyboard” on page 48 for details.
- ❑ If you connected an external mouse while your computer is on, you must restart your computer.
- ❑ If you are using an optional Sony USB mouse PCGA-UMS1, check that the mouse is plugged into the USB connector.

My touchpad does not work

You may have disabled the touchpad while no mouse was connected to the computer. If so, you must enable the touchpad using Sony Notebook Setup. You can access Sony Notebook Setup from the Windows® Start menu.

I cannot use DV devices. The message “DV equipment seems to be disconnected or turned off” appears.

- ❑ Check that the DV device is turned on and that the cables are properly connected.
- ❑ If you are using multiple i.LINK® devices, the combination of the connected devices may cause unstable operation. In this case, turn off the power to all connected devices and disconnect unused devices. Check the connection, then turn on the power again.

My touchpad interprets a single tap as a double-click

Click the Mouse icon in the Control Panel and then change the button assignments in the Mouse Properties dialog box. One of the buttons is assigned to the double-click action.

My computer does not shut down

It is best to shut down your computer using the Shut Down command on the Windows Start menu. Using other methods, including those listed here, may result in loss of unsaved data. If the Shut Down command does not work properly, follow these steps:

- ❑ Restart the computer by pressing Ctrl+Alt+Delete. If this does not work, press the power button and hold it for at least four seconds to turn off the power.
- ❑ Unplug the computer from the AC adapter and remove the battery pack from your computer.

My PC card is not working

- ❑ Make sure the PC card is compatible with Windows.
- ❑ Use the Sony Notebook Setup utility to disable devices you are not currently using.

The sound of my computer's fan is too loud

Use the PowerPanel utility to change the Thermal Control Strategy setting to Quiet. This setting slows down the CPU fan speed. See the PowerPanel Help for more information.

I cannot print

- ❑ The default setting for the printer port mode is correct for most printers. If you cannot print, try changing the printer port mode. In Sony Notebook Setup, select the Printer tab. If the printer port mode is set to ECP, change it to bidirectional. If the printer port mode is set to bidirectional, change it to ECP. See “Displaying the Sony Notebook Setup Screen” in the online document *Customizing Your VAIO® Notebook* for details on using Sony Notebook Setup.
- ❑ Your connected printer may not function after the computer resumes from a power-saving mode. When this occurs, follow the procedures below to reset the printer connection:
 1. Right-click the My Computer icon on the desktop, and then select Properties.
 2. Click the Device Manager tab.
 3. Select Refresh, and then click OK. The printer should now function properly.

Power Management

The operating system may become unstable if a lower power state such as system hibernation is initiated and then changed before the operating system completely enters the lower power state. To restore the computer to its normal operating stability, close all open applications, press the power button, and hold it for four seconds or more to completely shut down the computer.

Using the System and Application Recovery CDs

The following sections describe how to use the System Recovery and Application Recovery utilities.

Using the System Recovery CD(s)

You can reinstall software titles that shipped with your computer if they are corrupted or accidentally erased. You may not need to recover the entire contents of your hard drive. If you experience a problem with your computer, reinstalling an individual device driver or software title may correct the problem. Use the Application Recovery CD(s) to reinstall individual applications or device drivers. See “Using the Application Recovery CD(s)” on page 62.

The System Recovery CD contains a backup copy of all the software originally installed on your hard disk drive. It can be used only to recover the hard disk of the notebook you purchased.

The System Recovery utility gives you three options:

- ❑ **Full Restore without Format** restores all the software titles that originally came with your computer without formatting the hard disk. Word 2000 must be restored from the enclosed CD-ROM.
- ❑ **Full Restore with Format** formats the hard disk drive and then restores all the original software. If your hard drive is partitioned into C and D drives, the computer offers you the option to reformat the drive into a single partition. Word 2000 must be restored from the enclosed CD-ROM.
- ❑ **Operating System Only** restores the Windows® operating system, the notebook utility programs, and the device drivers that shipped with your computer.



If you choose the Full Restore with Format or Operating System Only option, your hard disk will be formatted, which removes all the information on the hard disk drive. You will lose any software you have installed and any other files you have created since you started to use your computer. This means you will have to reinstall any applications that were not included with the computer when you purchased it. If you choose the Full Restore without Format option, you may need to reinstall applications that were not included with the computer when you purchased it. If you have any questions on using the System Recovery CD, contact Sony Customer Support.

To use the System Recovery CD(s)

1. Insert the Sony System Recovery CD in the CD-ROM drive.
2. Shut down your computer as described in “Shutting Down Your Computer” on page 14.
3. Wait four seconds and turn on your computer.
4. Click OK to signify you have read and accept the Microsoft End-User License Agreement.
5. When the System Recovery menu appears, follow the on-screen instructions to complete the recovery process.

If your computer does not start from the Recovery CD

1. Press the power button and hold it for more than four seconds to turn off the computer.
2. Turn on the computer. When the Sony logo is displayed, press the F2 key. The BIOS setup menu screen appears.
3. Press the arrow keys to select the Exit menu.
4. Press the arrow keys to select Get Default Values and then press the Enter

Using the Application Recovery CD(s)

The Application Recovery CD(s) allows you to reinstall individual applications and device drivers if they are corrupted or accidentally erased. Reinstalling an individual device driver or software title may correct a problem you are experiencing with your computer, and you may not need to recover the entire contents of your hard drive. If you do need to reinstall all the software titles that shipped with your computer, use the System Recovery CD(s). See “Using the System Recovery CD(s)” on page 60.

You can also use the Application Recovery CD to install Windows NT® Workstation 4.0 drivers on your computer.



You must be in Windows to run the Application Recovery CD. The application will not run from DOS. If you have any questions on using the Application Recovery CD, contact Sony Customer Support.

To use the Application Recovery CD(s)

1. Turn on your computer. If your computer is already on, close all applications.
2. When the Windows desktop appears, insert the Sony Application Recovery CD in the CD-ROM drive. The Application Recovery utility loads automatically.
3. When the Application Recovery menu appears, select the icon for the application you want to restore and then follow the on-screen instructions to complete the recovery process.



Your system may include one or two Application Recovery CDs. If you have two Application Recovery CDs, insert the first CD to run the Application Recovery program. You may be prompted to insert the second CD, depending on the application you wish to restore.

Adding Memory

In the future you may want to install memory modules to expand the functionality of your computer. Your system comes with 64 MB of installed memory (64 MB x 1). By inserting optional memory modules in your computer's expansion slot, you can increase the memory up to 256 MB (128 MB x 2). 64 MB and 128 MB expansion memory modules are available as optional memory modules. For memory upgrades, use only PC-100 SDRAM SO-DIMM (gold lead contacts). Sony computer supplies, accessories, and peripherals can be purchased from your Sony-authorized dealer or by contacting Sony at <http://www.sony.com/accessories>.



The size of your memory may differ if you purchased a specially configured system.



Make sure you observe the proper safety precautions when you install memory modules in your computer. See the bulleted list below. Be careful when adding memory. Mistakes when installing or removing a memory module may cause a malfunction.

- The procedures described below assume familiarity with the general terminology associated with personal computers and with the safety practices and regulatory compliance required for using and modifying electronic equipment.
- Disconnect the system from its power source and from any telecommunications links, networks, or modems before you open the system or follow any of the procedures described below. Failure to do so may result in personal injury or equipment damage.
- Electrostatic discharge (ESD) can damage memory modules and other components. Perform the procedures described below only at an ESD workstation. If such a station is not available, do not work in a carpeted area, and do not handle materials that produce or hold static electricity

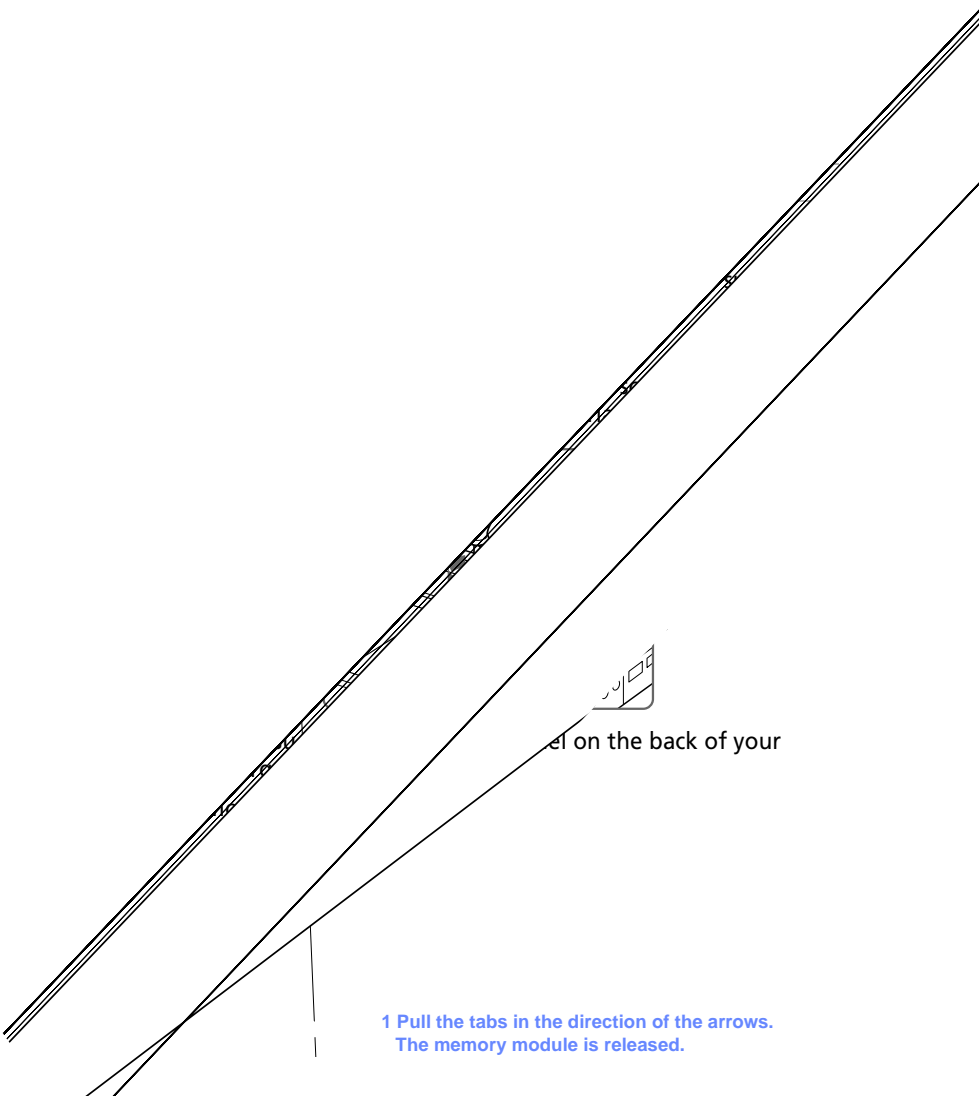

el on the back of your

**1 Pull the tabs in the direction of the arrows.
The memory module is released.**

6. Tighten the screw on the bottom cover.



Your computer comes with a memory module. To upgrade your memory you will need to remove this module and install your upgrade memory.

The memory slot is located on the bottom cover of your computer.

To install a memory module

1. Follow steps 1 to 4 of "To remove a memory module."
2. Remove the memory module from its packaging.
3. Install the memory module.

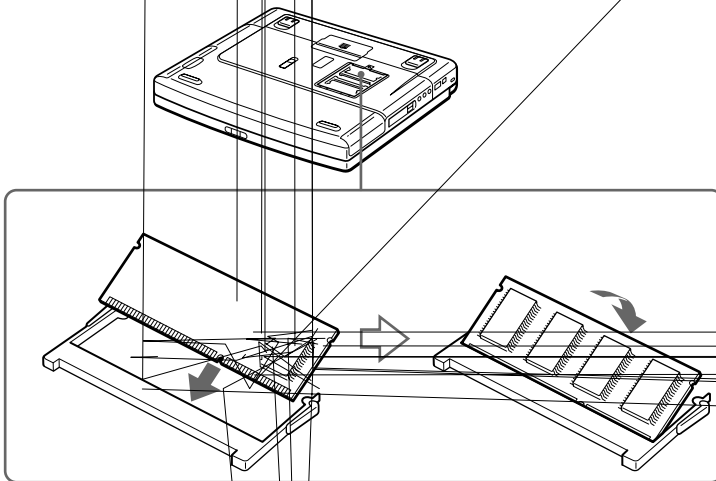

4. Tighten the screw on the bottom of the computer.

To view the amount of memory

1. Turn on the computer.
2. Click the Start button, point to VAIO, and click "Sony Notebook Setup."

The Sony Notebook Setup screen appears.

3. Click the "About This Computer" tab to view the amount of system memory. If the additional memory is not shown, repeat steps 1-4 in "To install a memory module."

Specifications

<i>Model</i>	<i>PCG-F520</i>
<i>Processor</i>	500 MHz* Intel® Pentium® III
<i>Hard Disk Drive</i>	6.0 GB†
<i>Standard RAM</i>	64 MB SDRAM, expandable to 256 MB
<i>LCD Screen</i>	13.0" SVGA HPA
<i>L2 Cache Memory</i>	256 KB (on die)
<i>MPEG</i>	MPEG1
<i>Graphics</i>	128-bit accelerator with 2.5 MB SGRAM
<i>Sound Capabilities</i>	16-bit CD-quality stereo sound
<i>Diskette Drive</i>	Removable 3.5" 1.44 MB
<i>CD-ROM Drive</i>	Reads CD data from 10.3X to 24X variable transfer rate.**
<i>Laser Diode Properties</i>	CD-ROM drive wave length 795 nm; laser output 16.5 μW
<i>Modem</i>	K56flex™ technology/V.90 compatible modem††
<i>Infrared</i>	Supports 4 Mbps, 1.1 Mbps, and 115 Kbps IrDA Standard
<i>Drive Bay</i>	Supports floppy disk drive (included) Supports second rechargeable battery (optional)
<i>Expansion Capabilities</i>	Type II PC cards and Type III PC card Card Bus support
<i>Built-in Capabilities</i>	Microphone Stereo speakers Digital touch pad
<i>Telecommunication Capabilities</i>	Data and fax send/receive††
<i>Connection Capabilities</i>	2 USB ports i.LINK Serial port Keyboard/mouse (PS/2® style) VGA monitor Video out Parallel (printer) Phone line (RJ-11) Microphone Headphone Port replicator Infrared port
<i>Supplied Accessories</i>	Video cable Floppy disk drive Rechargeable battery AC adapter and power cord Weight saver
<i>Service</i>	90-day limited express service*** Extendible to one year from original date of purchase upon registration

<i>Model</i>	<i>PCG-F520</i>
<i>Limited Warranty</i>	90-day parts/labor standard*** Extendible to one year from original date of purchase upon registration
<i>Power Requirements</i>	49.5 watts maximum (19.5V DC/AC 120-240V)
<i>Power Management</i>	Energy Star compliant Advanced Configuration and Power Interface (ACPI)
<i>Battery</i>	Lithium-ion, supports dual battery operation
<i>Dimensions</i>	12.7"(w) x 1.9"(h) ^{†††} x 10.4"(d) (324 x 46.9 x 265.5 mm)
<i>Weight</i>	7.0 lbs. (3.2 kg) (with battery and weight saver) 7.4 lbs. (3.4 kg) (with battery and floppy disk drive)
<i>Operating Temperature</i>	41° F to 95° F (+5° C to 35° C) temperature gradient less than 18° F (10° C) per hour
<i>Operating Humidity</i>	20% to 80% (not condensed), provided that humidity is less than 65% at 95° F (35° C), hygrometer reading of less than 84° F (29° C)
<i>Storage Temperature</i>	-4° F to 140° F (-20° C to 60° C), temperature gradient less than 18° F (10° C) per hour
<i>Storage Humidity</i>	10% to 90% (not condensed) provided that humidity is less than 20% at 140° F (60° C), hygrometer reading of less than 95° F (35° C)

* MHz denotes microprocessor internal clock speed; other factors may affect application performance.

† The size of your hard disk may differ if you purchased a specially configured system. GB means one billion bytes when referring to hard drive capacity. Accessible capacity may vary.

** Data on a CD-ROM is read at a variable transfer rate, ranging from 10.3X at the innermost track to 24X at the outermost track (the data transfer standard 1X rate is 150 kbytes/s). The average data transfer rate is 17.2X or 2580 kbytes/s.

†† Maximum speed for faxing is 14.4 kbps. Your modem is capable of downloading at maximum of 56 kbps using K56flex technology or V.90. Your online service or Internet Service Provider, however, may not support this technology or operate at this speed.

***Certain restrictions apply.

††† Height measured at thickest point. Thinnest height is 35.8 mm (1.4").

Specifications are subject to change without notice.

Index

A

- AC adapter **5, 9**
- AC power **9**
- adding
 - hardware **39**
 - memory **63**
 - peripherals **39**
 - printers **45**
- adjusting
 - brightness **13, 19**
 - contrast **19**
- Alt key **17**
- Application Recovery CD **62**
- Applications key **17**
- attaching port replicator **42**

B

- battery packs **5, 9**
 - charging **10, 36**
 - indicator light status **11**
 - indicator lights **5, 11, 18, 35**
 - inserting **9**
 - inserting into battery bay **9**
 - loading **9**
 - power status **11**
 - rechargeable **9**
 - removing **12, 35, 36**
- brightness
 - adjusting **13, 19**
- built-in speakers **5**
 - See also speakers **19**
- buttons
 - Eject **25, 26**
 - left **5**
 - right **5**

- Start (Windows 98) **14**

C

- cables
 - phone **5**
 - power cord **9**
- cameras
 - digital video recorder **51**
- canceling commands **16**
- Caps Lock **5**
 - indicator light **18**
- CD-ROM/DVD-ROM discs
 - ejecting **26**
 - inserting **25**
 - troubleshooting **55**
- charge status indicator light **11**
- charging battery packs **10, 36**
- choosing
 - power source **9**
- coin-operated telephones **40**
- computer
 - lithium ion battery **vi**
 - setting up **5**
 - starting **13**
 - troubleshooting **53, 55**
 - unpacking **3**
- connecting
 - coin-operated telephones **40**
 - digital video recorder **51**
 - external keyboard **41**
 - external speakers **49**
 - hard drives **27**
 - microphone **50**
 - monitor **41, 46**
 - mouse **41**

- multimedia computer display **46**
- multiple phone lines **40**
- network **27, 41**
- party phone lines **40**
- PBX **40**
- phone line **40**
- port replicator **41, 42**
- power source **9**
- printer **45**
- projector **47**
- USB device **52**
- weight saver **37**
- connectors
 - DC In **9, 41**
 - headphone **6**
 - i.LINK **6**
 - infrared **31**
 - keyboard **5, 7, 41**
 - Line In **6**
 - microphone **6**
 - monitor **41**
 - mouse **7, 41**
 - network **41**
 - Printer **7, 45**
 - printer **45**
 - Serial port **41**
 - USB **7, 41**
- contrast
 - adjusting **19**
- correction keys **16, 17**
- Ctrl key **17**
- cursor-movement keys **17**
- D**
 - DC In **9, 41**
 - digital still camera **31**
 - digital video camera **51**
 - disconnecting port replicator **44**
 - diskettes
 - ejecting **23**
 - inserting into drive **23**
 - troubleshooting **56**
- display
 - options **47**
 - See also monitor
 - selecting **47**
- disposal of lithium ion battery **vi**
- drives
 - floppy disk **5**
 - installing additional hard disk **27**
- DV devices
 - troubleshooting **57**
- DV In/Out **51**
- DVD-ROM drive
 - closing tray **26**
 - opening tray **25**
 - using **25**
- DVD-ROM drive tray
 - troubleshooting **55**
- E**
 - Eject button **23, 25, 26**
 - ejecting
 - battery packs **36**
 - CD-ROM/DVD-ROM discs **26**
 - diskettes **23**
 - weight saver **38**
 - Energy Star **ii**
 - Escape key **16**
 - expansion memory configuration **64**
 - Express Service technical support **15**
 - external devices
 - display **47**
 - See also monitor
 - speakers **19, 49**
- F**
 - fan **58**
 - faxes
 - laws governing **v**
 - floppy disk drive **5**
 - cable **5**
 - disconnecting **24**
 - troubleshooting **56**
 - Fn **20**
 - Fn key **17**
 - combination commands **19**
 - function keys **16, 17**
- H**
 - hard drives
 - indicator light **5, 18**

- installing additional **27**
- headphone connector **6, 46**
- Help
 - Mouseware **22**

I

- i.LINK **6, 51**
- IEEE-1394 **51**
- indicator lights **18**
 - battery **5, 11, 18, 35**
 - Caps Lock **5, 18**
 - charge status **11**
 - hard drive **5, 18**
 - Num Lock **5, 18**
 - power **5**
 - Scroll Lock **5, 18**
- infrared communication devices **31**
 - other computers **31**
- infrared port **31**
- infrared transmission
 - active distance **32**
 - troubleshooting **32**
- input devices **iv**
- Insert key **17**
- inserting
 - battery pack **9**
 - CD-ROM/DVD-ROM discs **25**
 - diskettes into drive **23**
- installing
 - hard drives **27**
 - hardware **39**
 - memory module **65**
 - peripherals **39**
- interference **iv**
- internal speakers
 - See speakers

K

- keyboard **17, 41**
 - connector **5, 7**

L

- LCD **5**
 - lock lever **13**
 - selecting to display output **47**
 - troubleshooting **54**

- LCD (Video) Standby mode **54**
- LED indicator **23**
- left button **5**
- lever
 - LCD **13**
 - weight saver release **36**
- Limited Warranty card **15**
- Line In **6**
- Liquid Crystal Display screen
 - See LCD
- lithium ion battery
 - disposal **vi**
 - safety precautions **vi**
- loading
 - battery pack **9**

M

- memory module
 - expansion **64**
 - installing **65**
 - removing **64**
- microphone **6**
 - connecting **50**
 - connector **46**
 - troubleshooting **57**
- modem
 - laws governing **v**
 - troubleshooting **56**
- monitor **7, 41**
 - connecting **46**
 - connector **46**
 - selecting **47**
 - switching among **19**
- mouse
 - connector **7**
 - troubleshooting **57**
- Mouse Properties screen **22**
- Mouseware
 - accessing help **22**
 - features **22**
- multimedia computer display **46**
- multiple phone lines **40**

N

- navigation keys **16, 17**
- network

- connecting **27**
- connector **41**
- port replicator **41**
- Notebook Computer **5**
- Num Lock **5**
 - indicator light **18**
- numeric keypad area **16**

O

- opening
 - DVD-ROM drive tray **25**
- operator keys **17**
- output devices **iv**
 - adding **45**

P

- party phone lines **40**
- PBX **40**
- PC card
 - inserting **27**
 - release button **27**
 - removing **29**
 - slot protector **28**
 - slots **27**
 - troubleshooting **58**
- phone
 - cable **5**
 - connecting line **40**
 - jack **40**
 - laws governing **v**
- port replicator
 - connecting **41, 42**
 - disconnecting **44**
 - lever **44**
 - network **41**
- power **18**
 - cord **9**
 - indicator light **5**
 - switch **13**
- power saving modes **33**
 - System Hibernation **20, 34**
 - System Idle **20, 33**
 - System Suspend **34**
 - Video Standby **20**
- power sources **9**
 - connecting **9**

- Print Screen key **16**
- printer **7**
 - connecting **41, 45**
 - connector **45**
 - port **45**
 - troubleshooting **58**
- Printer connector **7, 41, 45**
- Programmable Power Keys (PPK),
using **21**
- projector **47**

R

- radio interference **iv**
- rechargeable battery packs **9**
- recharging battery packs **10**
- Recovery CD **62**
- registering
 - your computer **15**
- removing
 - battery packs **12**
 - diskettes **23**
 - floppy disk drive **24**
 - memory module **64**
- replacing
 - battery packs **35**
- restoring data **62**
- right button **5**

S

- screen
 - See LCD
- Scroll Lock **5**
 - indicator light **18**
- second battery pack **9, 35**
- selecting
 - display **47**
 - LCD **47**
 - monitor **47**
 - power source **9**
- Serial connector **41**
- Shift key **17**
- Shut Down Windows dialog box **14**
 - shutting down **14**
 - troubleshooting **58**
- speakers **5**
 - built-in **5**

- external **49**
- switching **19**
- troubleshooting **56**
- volume **19**
- Specifications **66**
- Start button **14**
- starting
 - computer **13**
- startup problems **14**
- switching
 - display **19**
 - monitor **19**
- System Hibernation mode **20, 34**
- System Idle mode **20, 33**
- System Recovery CD **60**
- System Suspend mode **19, 34**

T

- touchpad **5, 22, 57**
- troubleshooting **53**
 - startup **14, 53**
- turning on
 - computer **13**
- TV
 - interference **iv**

U

- unpacking the computer **3**
- USB
 - connecting **52**
 - connector **7, 41, 52**
 - mouse **52**

V

- ventilation slot **8**
- video camera **51**
- Video Standby mode **20**
- viewing the amount of memory **65**
- volume control **19**
 - of fan **58**
 - troubleshooting **56**

W

- warranty **15**
- weight saver
 - attaching **35**

- connecting **37**
- fold-out arm **37**
- removing **38**
- Windows 98
 - Control Panel **32**
 - Explorer **17**
 - Find window **17**
 - help **17**
 - key **17**
 - key combinations **17**
 - Start button **14**
 - taskbar **14, 55**

